

Regoplast®

Manufacturer of innovative labelling solutions



LABELLING SYSTEMS

**PROFESSIONAL LABELLING SYSTEMS FOR
INDUSTRY, CRAFT AND TRANSPORT**



**RELIABLE.
INNOVATIVE.
FAST.**



INNOVATIONS FOR INDUSTRY AND CRAFT

We specialise in high-quality markings for pipes, cables and various plant areas. Our portfolio ranges from test badges, cable markers and plug-in labels to engraving plates, building labelling and badges. Our products are used in the chemical and petrochemical industry, the heating oil and mineral oil sector, plant and mechanical engineering, process engineering and the food industry.

ABOUT REGOPLAST















We have been dedicated to providing solutions for innovative labelling systems for over 40 years. But although our concepts have been successfully established on the market for many years, we are not afraid to change things and break new ground: We are constantly expanding our product range, finding solutions to the problems that arise in the industry and continuously improving our products.

Our customers can always rely on one thing: our constantly growing expertise, the high quality of our products and the sustainability that comes with them. Large companies and institutions also appreciate this, as the list of our references shows. They include names such as BASF, Böhringer, Sachsenmilch, Dresdner Kühlanlagenbau oder Z.I.S. Spezialbaustoffe GmbH.

LABELING SYSTEMS FOR HAZARDOUS GOODS TRANSPORTS

In addition to products for marking pipes and cables, our range also includes dangerous goods labels with matching holders, patented warning signs and numerous other labelling systems that we have developed specifically

CONTENTS

| | | |
|--|---------|---|
| Introduction | 2 - 5 | |
| Sign holders and plug-in signs | 6 + 7 |  |
| Sign holders and meter goods | 8 + 9 |  |
| Fastening technology | 10 + 11 |  |
| Weld-on and screw-on holders | 12 + 13 |  |
| PVC-sign inserts engraved and unengraved | 14 - 17 |  |
| PVC-signs & engraving plates | 18 - 21 |  |
| Engraving material | 22 + 23 |  |
| Vacuum plug-in signs for plates for pipework and container labelling | 24 - 29 |  |
| Pipeline marking for industry and plant engineering | 30 + 31 |  |
| Cabel markers | 32 - 39 |  |
| Paper pressing | 40 + 41 |  |
| Inspection tags | 42 - 45 |  |
| (PVC) negative pressure signs and building labelling | 46 + 47 |  |
| Sign-in sheets | 48 + 49 |  |
| Badges | 50 + 51 |  |

for the transport of dangerous goods. You can find an overview of these products in our „Professional labelling systems for hazardous goods transports“ catalogue.



**HIGH QUALITY.
CUSTOMISED.
TRIED AND TESTED.**



Kaltwasser Chemie

WE PROVIDE ORIENTATION

When it comes to making industrial plants safer, we are at the forefront. Since the very beginning, we have specialised in labelling solutions that are tailored to the special requirements in their areas of application. These include, for example, weather resistance, resistance to most chemicals and above all, simple, safe and quick installation.



HIGHEST QUALITY IS A MATTER OF COURSE FOR US.

In addition to standard solutions, we also offer customisable products. So you are guaranteed to find the right one for your business. But take a look at the following pages to see the variety we offer for yourself.

SIGN HOLDERS AND PLUG-IN SIGNS

MARKING OF LINES OF ANY KIND: EXCELLENTLY PROVEN

Sign holders are a focal point of the Regoplast GmbH product range. The patented profile rail made of polypropylene with quick-assembly tape made of VA steel or polyamide has proven itself outstandingly in the marking of cables of all types.

In addition, our standard sign holders provide another option for attaching engraved signs or vacuum signs in various sizes to pipes, conduits and racks with steel strapping and/or quick-fit tape.

The sign holder can be used wherever a visual and in your function clear marking is desired, such as on pipelines. In addition to cable ties and quick-fit mounting tape, spacers or screw-on brackets made of steel or VA steel and pipe clamps also serve as fastening materials.

Plug-in signs

Regoplast® plug-in signs are manufactured using the negative pressure process. They are scratch resistant and durable. They are characterized by their universal use in a wide range of applications. Among other things, in the marking of supply lines, boilers and electrical distribution stations, as well as for shelving.

Plug-in label system

As a standard version you have 4 plug-in sign sizes to choose from: 30 / 47 / 83.5 / 200 mm. In the background Colour yellow or white and each with black imprint. For systematic storage we offer you an assortment box. It contains the alphabet, numbers 0-9, special characters and punctuation clearly arranged and always at hand. In addition, the perfect application includes our profile rail and quick assembly tape.

Both our sign holders and profile rails taper together to build tension that holds the sign in place. We cut the signs to fit the holders or rails. This eliminates the need for end caps – and saves costs.

Our plug-in signs are also available in other colours upon request!

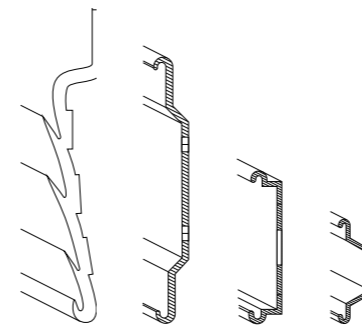

- ✓ Comprehensive parts program for size selection and fastening
- ✓ Complete service: inscribed insertable sign, sign holder, fastener
- ✓ Creation of proposals for your application

*Cross sections profile rails
 200 mm, 86.5 mm, 50 mm and 30 mm*



Assortment box made of metal with equipment negative pressure plug-in labels



Sign holder made of PA 6.6 with quick mounting strap made of polyamide. Screw-on and weld-on holders made of VA steel or galvanized steel.



Profile rail and base plate

SIGN HOLDERS AND METER GOODS



SIGN HOLDERS FOR SHELVES, TUBES AND PIPES

In order not to lose the overview in large warehouses or industrial plants, clearly visible markings are indispensable. Our sign holders make it possible.

Markings that can be mounted quickly and are not affected by the influences of everyday life in industry, transport and trade? This is a special challenge, but one that our sign holders are ideally suited to meet. Depending on the place of use, we offer them in different materials and designs.

Polyamide sign holder

For example, our polyamide sign holders are ideal for an industrial environment. They effortlessly withstand impacts, mechanical stress, acids, heat, cold and the changing weather. In large halls, where storage and transportation of goods are the main focus, aluminum or steel sign holders are more in demand. Depending on the type of sign holder, the technology for fastening also varies – however, efficiency, stability and thus safety are always in the foreground here as well.

Universal sign holder made of VA steel for fastening several and different rails to each other, are manufactured as required.

| Regoplast® Sign holder | | | | | | |
|------------------------|------------|--------|--|---|---------------------------|-------------|
| Material | Size in mm | Colour | Features | Fastening technology | Packaging unit | Item no. |
| Polyamide (PA) 6/6 | 100 x 50 | black | impact resistant, acid resistant, temperature resistant up to 95°C, lightfast, weather resistant | Tapes, plastic clamps, weld-on brackets, screw-on brackets, spacers | 100 | 110003 |
| | 120 x 50 | | | | 100 | 110004 |
| | 120 x 86.5 | | | | 100 | 110005 |
| | 200 x 86.5 | | | | 100 | 110006 |
| | 200 x 86.5 | | | | 100 | 110006/a |
| Aluminum | 116 x 50 | silver | for explosion protected areas | Tapes, plastic clamps, weld-on brackets, screw-on brackets, spacers | piece | 110020 |
| VA-Steel | 116 x 50 | | | | piece | 110021 |
| VA-steel | 116 x 50 | | | | with screws and thread M8 | Pipe clamps |

Other sizes of aluminum and VA steel sign holders on request.

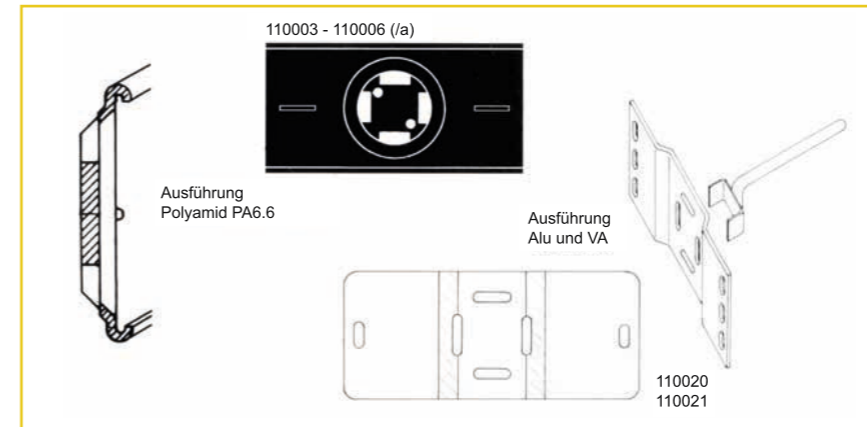

Universal bracket made of VA steel for mounting different rails.

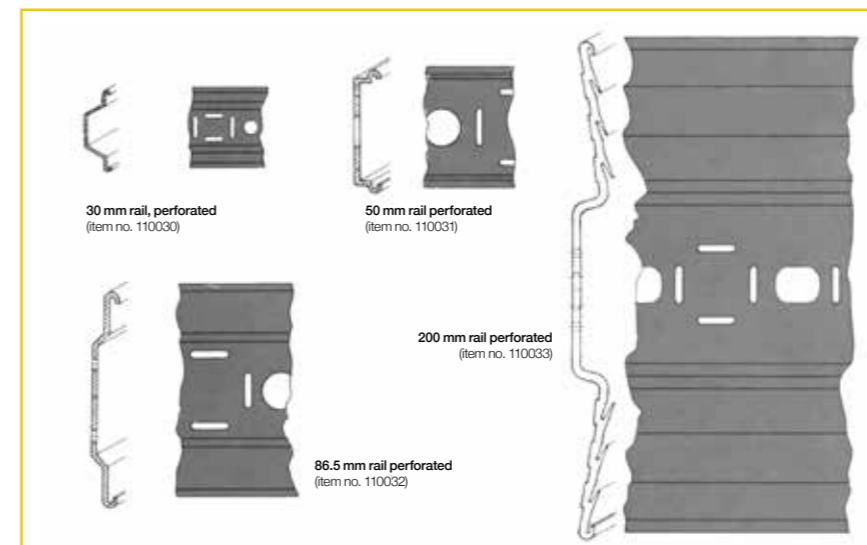

Sign holders in various designs: impact-resistant, acid-resistant or temperature-resistant up to 95 °C or for use in explosion-proof areas.

Regoplast® sign holder metre goods (profile rail)

In order to be able to mount several sign holders (metre goods) among each other, we supply multi-part supports made of VA steel for all versions of yard goods (also in different combinations).

| Material | Size in mm | Colour | Features | Fastening technology | Packaging unit | Item no. |
|----------|--------------|--------|------------------------|---|----------------|----------|
| Hard PVC | 1,000 x 30 | black | perforated and slotted | Tapes, plastic clamps, weld-on brackets, screw-on brackets, spacers | piece | 110030 |
| | 1,000 x 50 | | | | piece | 110031 |
| | 1,000 x 86.5 | | perforated and slotted | Tapes, plastic clamps, weld-on brackets, screw-on brackets, spacers | piece | 110032 |
| | 1,000 x 200 | | | | piece | 110033 |

We can cut the sign holder by the metre to any size you require.

| Cut to size by the metre (mm) | Item no. | Cut to size by the metre (mm) | Item no. |
|-------------------------------|----------|-------------------------------|----------|
| 1,000 x 30 | 110040 | 1,000 x 86.5 | 110042 |
| 1,000 x 50 | 110041 | 1,000 x 200 | 110043 |

FASTENING TECHNOLOGY



Fastening technology quick mounting tape

from the roll for all sign holders and goods by the metre except size 1,000 x 30 mm

| Material | Width mm | Features | Colour | Locking heads incl. | Package content | Item no. |
|---------------|----------|---------------|--------|---------------------|-----------------|----------|
| Polypropylene | 12.7 | - | black | 15 | 10 m roll | 120060 |
| | | | | 30 | 25 m roll | 120061 |
| | | | | 75 | 50 m roll | 120062 |
| | | | | 500 | 300 m roll | 120064 |
| Polyamide 6/6 | - | Locking heads | | 100 | - | 120070 |

Fastening technology

from the roll for all sign holders and goods by the metre except size 1,000 x 30 mm

| Material | Width mm | Features | Colour | Locking heads incl. | Package content | Item no. |
|------------------|----------|---------------|---------------|---------------------|-----------------|----------|
| Steel galvanised | 13 | - | nature | - | 30 m roll | 120076 |
| | | Locking heads | | 50 | - | 120077 |
| VA-steel 1.4016 | 13 | - | | - | 30 m roll | 120078 |
| | | Locking heads | | 50 | - | 120079 |
| VA-steel | 8 | - | silver nature | - | 25 m roll | 120085 |
| | | Locking heads | | 100 | - | 120086 |

Fastening technology

| Material | Size in mm | Colour | Packaging unit | Item no. |
|---------------|------------|--------|----------------|----------|
| Polyamide 6.6 | 360 x 7.6 | black | 100 | 120080 |

Regoplast® Screw-on holder

- particularly suitable for mounting flanges in manifolds

| Material | Hole ø | Utilisation | Version | Item no. | Version | Item no. |
|----------|--------|------------------------------------|----------|----------|---------|----------|
| Steel | 17 | Goods by the metre 1,000 x 50 mm | straight | 120100 | angled | 120101 |
| | | Goods by the metre 1,000 x 86.5 mm | | | | |
| | | Goods by the metre 1,000 x 200 mm | | | | |
| VA-steel | 17 | Sign holder 120 x 86.5 mm | straight | 120102 | angled | 120103 |
| | | Sign holder 200 x 86.5 mm | | | | |
| Steel | 17 | Sign holder 100 x 50 mm | straight | 120104 | angled | 120105 |
| VA-steel | 17 | Sign holder 120 x 50 mm | straight | 120106 | angled | 120107 |
| Steel | 17 | only for metre goods 1,000 x 30 mm | straight | 120110 | angled | 120111 |
| VA-steel | 17 | perforated and slotted | straight | 120112 | angled | 120113 |



Item number 120060 - 120064
Quick mounting tape made of polypropylene
in rolls from 10 m to 300 m
load capacity up to 90 kp



Item number 120070
locking heads made of polyamide 6/6



Item number 120076
galvanised steel mounting tape
in rolls of 30 m; load capacity up to 170 kp



Item number 120078
assembly strap made of VA-steel
in rolls of 30 m; load capacity up to 260 kp

Item number 120077 + 120079
suiting locking heads
for Item number 120076 + 120078



Item number 120085
mounting tape made of VA-steel; silver natural
in rolls of 30 m



Item number 120080
cable ties made of polyamide 6.6; black
360 x 7.6 mm
packed per 100 pieces



Item number 120101, 120103, 120105, 120107, 120111, 120113
screw-on bracket made of steel or VA-steel;
angled design



Item number 120100, 120102, 120104, 120106, 120110, 120112
screw-on bracket made of steel or VA-steel;
straight version



Standard version suitable up to 0 NW 200.
Special design on request.

WELD-ON AND SCREW-ON HOLDERS



Sign holders are a focal point of Regoplast GmbH's product range. The patented profile rail made of polypropylene with quick-mounting tape made of VA-steel or polyamide has proven itself in the labelling of all types of cables. With

our standard sign holders, we also offer a further option for attaching engraved signs or printed signs in various sizes to pipes, cables and shelving using steel straps and/or quick-fit tape.

| Regoplast® Weld-on holder - suitable for assembly in the heating and construction field | | | | | |
|--|----------------|---|------------|--------|----------|
| Material | Version | Utilisation | Size in mm | | Item no. |
| | | | ø | Length | |
| Steel | large brackets | Goods by the metre 1,000 x 50 mm | 6 | 150 | 120120 |
| | | Goods by the metre 1,000 x 86.5 mm | | | |
| | | Goods by the metre 1,000 x 200 mm | | | |
| VA-steel | large brackets | Sign holder 120 x 86.5 mm | 6 | 150 | 120121 |
| | | Sign holder 200 x 86.5 mm | | | |
| Steel | small brackets | Sign holder 100 x 50 mm | 6 | 150 | 120125 |
| VA-steel | small brackets | Sign holder 120 x 50 mm | 6 | 150 | 120126 |
| Steel | mini brackets | only for goods by the metre 1,000 x 30 mm | 6 | 150 | 120130 |
| VA-steel | mini brackets | perforated and slotted | 6 | 150 | 120131 |

| Regoplast® Screw-on bracket with thread for pipe clamps | | | | | |
|---|----------------|---|------------|--------|----------|
| Material | Version | Utilisation | Size in mm | | Item no. |
| | | | ø | Length | |
| Steel | large brackets | for goods by the metre 1,000 x 50 mm | 6 | 150 | 120200 |
| | | for goods by the metre 1,000 x 86.5 mm | | | |
| | | for goods by the metre 1,000 x 200 mm | | | |
| VA-steel | large brackets | for sign holder 120 x 86.5 mm | 6 | 150 | 120300 |
| | | for sign holder 200 x 86.5 mm | | | |
| Steel | small brackets | for sign holder 100 x 50 mm | 6 | 150 | 120205 |
| VA-steel | small brackets | for sign holder 120 x 50 mm | 6 | 150 | 120305 |
| Steel | mini brackets | only for goods by the metre 1,000 x 30 mm | 6 | 150 | 120210 |
| VA-steel | mini brackets | perforated and slotted | 6 | 150 | 120310 |



Item number
120120, 120121, 120125, 120126, 120130
Weld-on bracket made of steel or VA-steel;
angled version with small or large clamps
in different versions



Item number 120200 - 120300
Steel or VA-steel spacers;
with large clamps
for goods by the metre



Item number 120205 - 120305
Steel or VA-steel spacers;
with small clamps
for sign holders and goods by the metre



Item number 120210 - 120310
Steel or VA-steel spacers;
with mini-clamps for goods by the metre



PVC-SIGN INSERTS

Kaltwasser Chemie

LABELLING OF VARIOUS MEDIA IN ACCORDANCE WITH DIN 2403 AND 2404



Regoplast® PVC label inserts for labeling various media according to DIN 2403 and 2404. This system is particularly suitable for systems with the same typeface, whereby the medium flowing in the pipeline can be indicated on both sides in each case in conjunction with Regoplast® sign

holders in the interests of accident prevention (e.g. steam, water, lye, etc.). There are 15 color combinations available according to the sample chain.



Regoplast® directional arrows - engraved or in negative pressure - enable the operating personnel to quickly recognise the direction of flow of the medium. Mounting options with signs in various Regoplast® sign holders.



Regoplast® PVC-Sign inserts suitable for Regoplast® sign holders in 15 colour combinations

| Packaging unit | Item no. | Size in mm |
|----------------|----------|------------------|
| 100 | 130403 | 100 x 47 x 1.25 |
| 100 | 120404 | 120 x 47 x 1.25 |
| 100 | 130405 | 120 x 83.5 x 1.2 |

| Packaging unit | Item no. | Size in mm |
|----------------|----------|-------------------|
| 100 | 130406 | 200 x 83.5 x 1.25 |

Also available in other materials on request (see description at the end of the chapter).

Regoplast® PVC-Sign inserts in various sizes according to price list

| Item no. |
|----------|
| 130410 |

Also available in other materials on request (see description at the end of the chapter).

Regoplast® PVC-Signs engraved in various sizes according to price list

| Item no. |
|----------|
| 130430 |

Size up to 400 x 300 mm. Thickness 1.25 mm. Width in 50 mm increments from 50 mm to 300 mm.



SELECT THE COLOUR ACCORDING TO YOUR SPECIFICATIONS

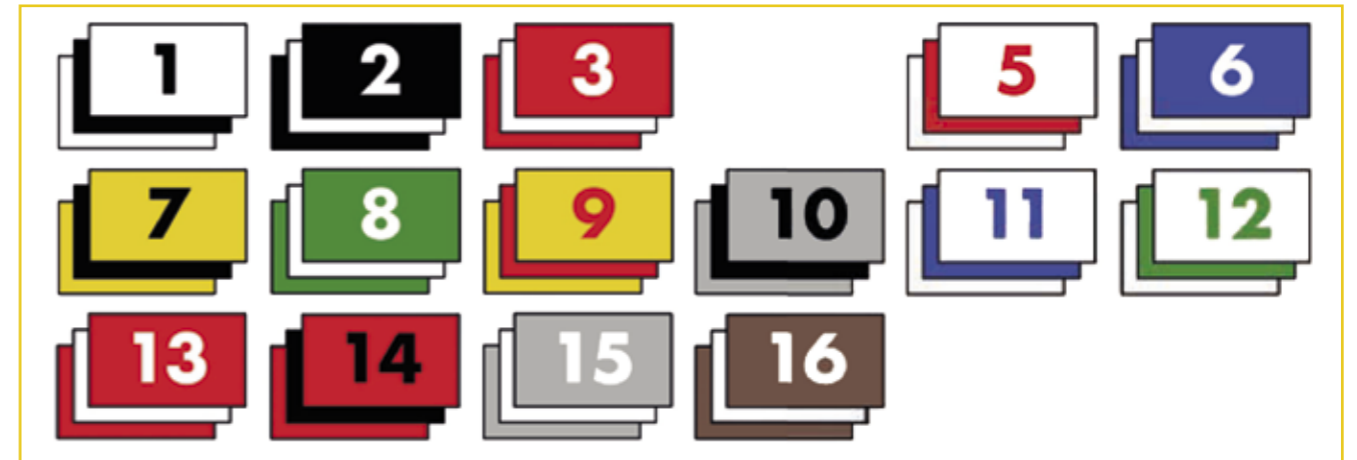

15 colour combinations according to the sample chain. Please state the colour-no. when ordering.
 Example: Order no. 130403/1 (1 = Base colour white / Text colour black).

| Regoplast®-PVC-Sign inserts | | | | | |
|--|-------------|-------------|------------|-------------|-------------|
| unmarked or engraved in the colour combinations according to DIN 2403 / 2404 | | | | | |
| Colour no. | Base colour | Text colour | Colour no. | Base colour | Text colour |
| 1 | white | black | 10 | grey | black |
| 2 | black | white | 11 | white | blue |
| 3 | red | white | 12 | white | green |
| 5 | white | red | 13 | orange | white |
| 6 | blue | white | 14 | orange | black |
| 7 | yellow | black | 15 | grey | white |
| 8 | green | white | 16 | brown | white |
| 9 | yellow | red | | | |

Also available in other materials and colours on request.





PVC-SIGNS & ENGRAVING PLATES

ENGRAVING PLATES MADE TO YOUR SPECIFICATIONS

We produce engraved signs according to your specifications on 3-layer non-translucent material. This allows both sides to be engraved without any disadvantages. The materials we use are PVC, Formatur, Resopal and Alu-Dibond. With PVC-Formalon® and Resopal, you have

a wide range of colors to choose from. From these, there are many possible combinations. The fonts are very visible and stand out.

The font height and thickness are adjusted, as is the placement of the font on the

substrate. We not only have the usual font types but can offer almost any font type. We assemble the engraved signs according to your specifications, if this is possible depending on the material.



Regoplast® PVC-Signs engraved and suitable to the sign holder

| Size mm | Version | Item no. | Size mm | Version | Item no. |
|-----------------|---|----------|-------------------|---|----------|
| 100 x 47 x 1.25 | including one engraved line (max. 20 letters) | 130420 | 120 x 83.5 x 1.25 | including one engraved line (max. 20 letters) | 130422 |
| 120 x 47 x 1.25 | | 130421 | 200 x 83.5 x 1.25 | | 130423 |

Detailed information in the price list (Formatur® material must be used for font heights up to and including 5 mm. This does not change the line prices - price list)

Engraved PVC signs up to size: 400 x 300 x 1.25 mm according to table (Price list)

| Item no. |
|----------|
| 140430 |

Engraved signs made of other materials on request.

Regoplast® PVC signs engraved and suitable for sign holder

| Material | Size mm | Thickness mm | Item no. | Material/ Colour | Size mm | Thickness mm | Item no. |
|----------|------------|--------------|-------------|------------------|-------------|--------------|----------|
| PVC | 1320 x 800 | 0.50 | 140490 | silver / black | 1,220 x 600 | 0.80 | 140500 |
| | | 0.75 | 140491 | | | 1.50 | 140501 |
| | | 1.00 | 140492 | | | 2.00 | 140502 |
| | | 1.25 | 140493 | 0.80 | | 140503 | |
| | | 2.00 | 140494 | 1.50 | | 140504 | |
| | | 2.25 | 140495 | 2.00 | | 140505 | |
| | 3.00 | 140496 | alu / black | 0.80 | 140506 | | |
| | | | | 1.50 | 140507 | | |
| | | | | 2.00 | 140508 | | |

Other thicknesses and colours on request. 3-layer melamine resin boards on request.

ENGRAVING PLATES ACCESSORIES



Classic white and blue - just one of many possibilities.



Font type and size can be varied almost at will.



We are happy to fulfil special requests such as these variable number fields for you.

FREEDOM IN TERMS OF COLOR DESIGN

Even if white font on a colored background has proven to be successful, this should not get in the way of your personal ideas. We offer numerous color combinations for signs, especially

for the signs made of PVC or Formica. But if you like it uncomplicated, you can also rely on our know-how and our recommendation.

FONTS AND SYMBOLS

In addition to all standard fonts, you can also choose almost any other font type. The engraving technique makes the letters stand out visually, which further improves their legibility. Our range is also supplemented by signs with

engraved directional arrows, which are advantageous for pipelines. Attached from the outside, they indicate the direction in which the respective medium flows inside the pipe.

EXTRAS DESIRED? IT'S A PLEASURE.

Those who move great things sometimes need great flexibility. This also applies to our customers, some of whom operate worldwide. We can easily

incorporate extras such as adjustable positions for changing dates, numbers or values into our engraved signs. Just ask us.

Regoplast® directional arrows engraved

(The directional arrows (in all 15 colour combinations) enable you to immediate recognition of the medium flow direction. Mounting options with signs in Regoplast® sign holders and yardage.

| Size mm | Version flow direction (arrow) | Item no. | Size mm | Version flow direction (arrow) | Item no. |
|------------------|--------------------------------|----------|--------------------|--------------------------------|----------|
| 30 x 30 x 1.25 | all directions | 140445 | 83.5 x 83.5 x 1.25 | all directions | 140465 |
| 47 x 20 x 1.25 | right / left | 140450 | 200 x 90 x 1.25 | right / left | 140470 |
| 47 x 20 x 1.25 | up / down | 140451 | 200 x 90 x 1.25 | up / down | 140471 |
| 47 x 47 x 1.25 | all directions | 140455 | 200 x 200 x 1.25 | all directions | 140475 |
| 83.5 x 30 x 1.25 | right / left | 140460 | | | |
| 83.5 x 30 x 1.25 | up / down | 140461 | | | |

Regoplast® Etching/marking pen

| Version | Text colour | Item no. |
|---------|-------------|----------|
| slim | black | 140510 |
| bold | | 140511 |



Pipeline labelling for industry and plant engineering



Pipeline labelling for industry and plant engineering



Etching pencil in slim and bold versions

Regoplast® DIN A4-Sign holder

| Item | Item no. |
|--|----------|
| Sign holder DIN A4, natural VA aluminium | 521824 |
| Sign holder DIN A4, natural aluminium | 521825 |
| Sign holder DIN A4, natural aluminium with PVC cover | 521825/a |



Our sign holders are available in various formats (e.g. DIN A4, DIN A5 ...)

ENGRAVING MATERIAL

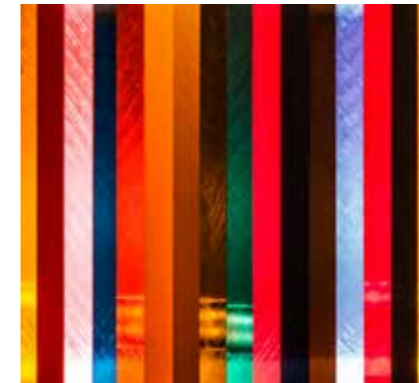

FORMAGLAS®

- film coated acrylic sheets
- cast
- Good dimensional stability
- weatherproof
- perfectly engravable
- Labeling on the back in mirror writing
- Laser processing (marking and cutting also possible)
- Prices incl. protective film application on one side



BRASS

- Gravure brass with high-gloss, polished or satin surface
- excellent quality from German production, MS 58
- perfectly engravable
- unvarnished
- Prices incl. protective film application on one side



ALUFORM MATTE

- High-quality matt sheet anodized on both sides according to DIN AIMg 3, G27 3/4 hard
- Strictly compacted according to DIN specification
- decorative anodized quality
- Anodized layer approx. 15 my
- best engraving quality
- engraving, printing and laser possible



FORMAPAL

- glossy, hard surfaces
- Melamine
- Largely resistant to solvents and chemicals
- flame retardant
- perfectly millable
- engravable on both sides
- Laser marking possible
- 12 brilliant colors in 3 colour groups



ALUFORM STAINLESS STEEL LOOK

- high quality DIN anodized ground plate ALMg 1
- decorative anodized quality
- engraving, printing and laser possible
- Surface sanded in stainless steel look, grain 1 80
- Grinding direction parallel to the long side, thus low wastage
- Prices incl. protective film application on one side



ALUFORM GLOSSY

- high quality glossy plate in quality Peraluman
- Alu-Suisse Singing, hard
- Anodized on both sides
- decorative anodized quality
- Anodized layer approx. 18 my
- best engraving quality
- engraving, printing and laser possible



**VACUUM
PLUG-IN
SIGNS**

Profile rail and base plate

ONE ASSORTMENT BOX - COUNTLESS POSSIBILITIES

Mounted on a profile rail, the labelling provides orientation in your company. And in the long term, too: the labels are made of high-quality rigid PVC, which is largely UV-stabilised, weather-resistant, scratch-resistant and also resistant to most acids and alkalis.

Our plug-in signs work according to a similar principle to a historical letter box - except that our letters are not made of lead, but of extremely resistant rigid PVC. This means that the letters, numbers and special characters can be flexibly combined and used in almost any area, for example to label supply lines, boilers, distribution stations or storage racks.

In order to guarantee the reliability and durability of the markings, we ensure - as with all our products - the highest stan-

dards in terms of materials and production. For example, we manufacture the rigid PVC lugin signs using the so-called vacuum printing process. This means that UV radiation, mechanical influences and chemicals cannot harm them later on.

This not only increases safety on site, but also makes an important contribution to sustainability. After all, it enables energy and materials to be used efficiently and with foresight.

30 mm vacuum plug-in labels

| Size mm H x W | Basecolour/ Textcolour | Packaging unit | Version Font height mm | Numbers / capital letters / symbols | Item no. |
|---------------|------------------------|----------------|---------------------------|--|----------|
| 30 x 21 | yellow / black | 100 | 25 | 0-9 / A-Z / slash, period, hyphen, comma, colon, phone symbol, blank, °C | 210800 |
| 30 x 21 | | 100 | Flow direction right/left | Arrow | 210810 |
| 30 x 30 | | 100 | all directions | Arrow | 210811 |
| 30 x 41 | | 100 | 25 | bar | 210812 |
| 30 x 21 | | 100 | 19 | m | 210813 |

Special symbols available on request for larger quantities. Please insert the desired symbol after the item no. 30 mm plug-in labels - suitable for 1,000 x 30 mm profile rails - see pipework labelling item no. 110030 and the fastening options listed there.

30 mm vacuum plug-in labels in assortment box

| Box size mm L x B | Basecolour/ Textcolour plug-in labels | Version Box | Content symbols | Quantity per symbol | Total parts | Item no. |
|-------------------|---------------------------------------|-------------|---|---------------------|-------------|----------|
| 485 x 365 | yellow / black | Sheet steel | 0-9 / A-Z / slash, period, hyphen, comma, colon | 30 | 41 / 1230 | 210830 |
| | | | " | 50 | 41 / 2050 | 210831 |
| | | | " | 75 | 41 / 3075 | 210832 |
| 650 x 450 | yellow / black | Wooden box | " | 100 | 41 / 4100 | 210833 |
| | | | " | 150 | 41 / 6150 | 210834 |

IF REQUIRED AND IN LARGER QUANTITIES, WE CAN PRODUCE SIGNS ACCORDING TO YOUR REQUIREMENTS AND THE DESIRED COLOUR.

WE ARE HAPPY TO CUSTOMISE LABELS ACCORDING TO YOUR SPECIFICATIONS.

47 MM VACUUM PLUG-IN LABELS



Our label boxes contain the complete alphabet from A to Z, all numbers from 0 to 9 and the special characters slash, full stop, hyphen, comma and colon. The number of individual symbols varies depending on the size of the assortment box,

as does the font height. In addition to the tried and tested combination of black characters on a yellow background, we also offer black characters on a white background.

| 47 mm vacuum plug-in labels | | | | | |
|-----------------------------|------------------------|----------------|------------------------|--|----------|
| Size mm H x W | Basecolour/ Textcolour | Packaging unit | Version Font height mm | Numbers / capital letters / symbols | Item no. |
| 47 x 25 | yellow / black | 50 | 35 | 0-9 / A-Z, slash, dot, hyphen, comma, colon, phone symbol, blank, °C | 210900 |
| 47 x 47 | | 50 | all directions | Arrow | 210920 |
| 47 x 50 | | 50 | 35 | bar | 210922 |
| 47 x 25 | | 50 | 25 | m | 210923 |
| 47 x 25 | white / black | 50 | 35 | 0-9 / A-Z, slash, dot, hyphen, comma, colon, phone symbol, blank, °C | 210950 |
| 47 x 47 | | 50 | all directions | Arrow | 210970 |
| 47 x 50 | | 50 | 35 | bar | 210972 |
| 47 x 25 | | 50 | 25 | m | 210973 |

Special symbols available on request for large order quantities. Please insert the desired symbol after the item number.
47 mm plug-in signs - suitable for meter goods (profile rails) 1000 x 50 mm - see pipe marking order no. 110031 and the mounting options listed there.

| 47 mm vacuum plug-in labels in assortment box | | | | | | |
|---|---------------------------------------|-------------|---|---------------------|-------------|----------|
| Size box mm L x W | Basecolour/ Textcolour plug-in labels | Version Box | Content symbols | Quantity per symbol | Total parts | Item no. |
| 485 x 365 | yellow / black | Sheet steel | 0-9 / A-Z, slash, dot, hyphen, comma, colon | 30 | 41 / 1230 | 220980 |
| | | | " | 50 | 41 / 2050 | 220981 |
| 650 x 450 | | Wooden box | " | 100 | 41 / 4100 | 220982 |
| | | | " | 150 | 41 / 6150 | 220983 |
| 485 x 365 | white / black | Sheet steel | 0-9 / A-Z, slash, dot, hyphen, comma, colon | 30 | 41 / 1230 | 220990 |
| | | | " | 50 | 41 / 2050 | 220991 |
| 650 x 450 | | Wooden box | " | 100 | 41 / 4100 | 220992 |
| | | | " | 150 | 41 / 6150 | 220993 |

Characters and dimensions in vacuum plug-in labels assortment box, character height 30 mm.
Item number: 210800

Profile and top view of the 30 mm profile rail.
Item number: 110030

Characters and dimensions in vacuum plug-in labels assortment box, character height 50 mm.
Item number: 210900/210950

Profile and top view of the 50 mm profile rail.
Item number: 110031

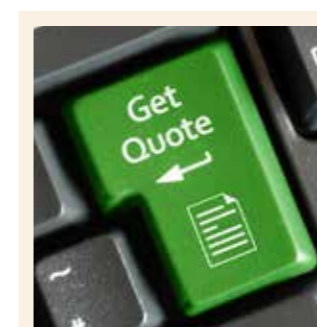

WE LOOK FORWARD TO YOUR ENQUIRY!

Do you have any questions, need advice or would like to request a quote? Then get in touch with us, either by phone or email. We will be happy to help you. For more information about our clip-on signs, you can also visit us at:

www.regoplast.de/en/products/sign-holders-and-plug-in-signs

83.5 AND 200 MM VACUUM PLUG-IN LABELS

| 83.5 mm vacuum plug-in labels | | | | | |
|-------------------------------|------------------------|----------------|------------------------|--|----------|
| Size mm H x W | Basecolour/ Textcolour | Packaging unit | Version Font height mm | Numbers / capital letters / symbols | Item no. |
| 83.5 x 35 | yellow / black | 50 | 56 | 0-9 / A-Z, slash, dot, hyphen, comma, colon, phone symbol, blank, °C | 221000 |
| 83.5 x 30 | | 50 | up / down | Arrow | 221008 |
| 83.5 x 30 | | 50 | right / left | " | 221009 |
| 83.5 x 83.5 | | 50 | all directions | " | 221010 |
| 83.5 x 35 | white / black | 50 | 56 | 0-9 / A-Z, slash, dot, hyphen, comma, colon, phone symbol, blank, °C | 221030 |
| 83.5 x 30 | | 50 | up / down | Arrow | 221038 |
| 83.5 x 30 | | 50 | right / left | " | 221039 |
| 83.5 x 83.5 | | 50 | all directions | " | 221040 |
| 83.5 x 35 | blue / white | 50 | 56 | 0-9 / A-Z, slash, dot, hyphen, comma, colon, phone symbol, blank, °C | 221050 |
| 83.5 x 83.5 | | 50 | all directions | Arrow | 221060 |

Special symbols available on request for large order quantities. Please insert the desired symbol after the order no. in each case. 83.5 mm plug-in signs - suitable for meter goods (profile rails) 1000 x 86.5 mm - see pipe marking order no. 110032 and the mounting options listed there.

| 83.5 mm vacuum plug-in labels in assortment box | | | | | | |
|---|---------------------------------------|-------------|---|---------------------|-------------|----------|
| Size box in mm (LxW) | Basecolour/ Textcolour plug-in labels | Version box | Content symbols | Quantity per symbol | Total parts | Item no. |
| 650 x 450 | yellow / black | Wooden box | 0-9 / A-Z, slash, full stop, hyphen, comma, colon | 30 | 41 / 1230 | 231070 |
| 650 x 450 | yellow / black | Wooden box | " | 50 | 41 / 2050 | 231071 |
| 650 x 450 | yellow / black | Wooden box | " | 100 | 41 / 4100 | 231072 |
| 650 x 450 | yellow / black | Wooden box | " | 150 | 41 / 6150 | 231073 |
| 650 x 450 | white / black | Wooden box | 0-9 / A-Z, slash, full stop, hyphen, comma, colon | 30 | 41 / 1230 | 231080 |
| 650 x 450 | white / black | Wooden box | " | 50 | 41 / 2050 | 231081 |
| 650 x 450 | white / black | Wooden box | " | 100 | 41 / 4100 | 231082 |
| 650 x 450 | white / black | Wooden box | " | 150 | 41 / 6150 | 231083 |
| 650 x 450 | blue / white | Wooden box | 0-9 / A-Z, slash, full stop, hyphen, comma, colon | 30 | 41 / 1230 | 231090 |
| 650 x 450 | blue / white | Wooden box | " | 50 | 41 / 2050 | 231091 |
| 650 x 450 | blue / white | Wooden box | " | 100 | 41 / 4100 | 231092 |
| 650 x 450 | blue / white | Wooden box | " | 150 | 41 / 6150 | 231093 |

| 200 mm vacuum plug-in labels | | | | | |
|------------------------------|-------------------------|----------------|------------------------|-------------------------------------|----------|
| Size in mm (HxW) | Basecolour / Textcolour | Packaging unit | Version Font height mm | Numbers / capital letters / symbols | Item no. |
| 200 x 90 | blue / white | piece | 142 | 0-9 / A-Z / blank | 231100 |
| 200 x 90 | white / red | piece | 142 | 0-9 / A-Z / blank | 231150 |

Special symbols available on request for large order quantities. Please insert the desired symbol after the order no. in each case. 200 mm plug-in signs - suitable for meter goods (profile rails) 1000 x 200 mm - see pipe marking order no. 110033 and the mounting options listed there.

0 1 2 3 4 5 6 7 8 9 A B C D E F
G H I J K L M N O P Q R S T U V
W X Y Z . / , - : °C

86.5 mm

Characters and dimensions in vacuum plug-in labels assortment box, character height 86.5 mm.
Item number: 221000 | 221050

Profile and top view of the 86.5 mm profile rail.
Item number 110032

0 1 2 3 4 5 6 7 8 9 A - Z

200 mm

Characters and dimensions in vacuum plug-in labels assortment box, character height 200 mm.
Item number: 231100 | 231150

PIPELINE MARKING FOR INDUSTRY AND PLANT ENGINEERING

WE PRODUCE SIGNS WITH YOUR DESIRED TEXT!

PIPELINE MARKING FOR INDUSTRY AND PLANT ENGINEERING

Medium identification for supply lines on pipe bridges etc. Regoplast® lettering panels are made of rigid PVC, are largely UV-stabilized, scratch-resistant and resistant to acids, alkalis and other chemicals. As a result, they have a longer service life than conventional signs. Colours according to DIN 2403/2404.

Regoplast® GmbH has more than 40 years of experience in the manufacture of weather-resistant signage systems. These are used in many areas of industrial and plant marking. On request, we can create signs according to your specifications and from various materials (PVC, Resopal® and vacuum signs). Possible finishes: en-

graved, underprint process and printed by digital or screen printing. Basically, we offer, in combination with different fastening materials, metal or plastic as a carrier material. Here, too, our sign holders or profile rails from the "Sign holders & plug-in signs" range are used as support elements.

ACETYLEN

WASSERSTOFF

bar

KOHLENDIOXID

Arb.-Luft

SYNTH.-LUFT

Medium identification for supply lines on pipe bridges etc.

| Size in mm (LxH) | Basecolour / Textcolour | Packaging unit | Text* | Font size in mm | Item no. |
|------------------|-------------------------|----------------|--------------------------------|-----------------|----------|
| 185 x 83.5 | yellow / black | piece | Abluft (Exhaust air) | 53 | 241200 |
| 445 x 83.5 | yellow / black | piece | ACETYLEN | 53 | 241201 |
| 280 x 83.5 | yellow / black | piece | ARGON | 53 | 241202 |
| 170 x 83.5 | yellow / black | piece | BAR | 53 | 241203 |
| 300 x 83.5 | yellow / black | piece | Erdgas (Natural gas) | 53 | 241204 |
| 335 x 83.5 | yellow / black | piece | ERDGAS (NATURAL GAS) | 53 | 241205 |
| 475 x 83.5 | yellow / black | piece | FORMIERGAS (FORMING GAS) | 53 | 241206 |
| 280 x 83.5 | yellow / black | piece | HELIUM | 53 | 241207 |
| 525 x 83.5 | yellow / black | piece | KOHLENDIOXID (CARBON DIOXIDE) | 53 | 241208 |
| 300 x 83.5 | yellow / black | piece | PROPAN | 53 | 241209 |
| 460 x 83.5 | yellow / black | piece | STICKSTOFF (NITROGEN) | 53 | 241210 |
| 585 x 83.5 | yellow / black | piece | WASSERSTOFF (HYDROGEN) | 53 | 241211 |
| 340 x 83.5 | yellow / black | piece | Wasserstoff (Hydrogen) | 53 | 241212 |
| 105 x 83.5 | red / white | piece | bar | 53 | 241220 |
| 185 x 83.5 | red / white | piece | Dampf (Steam) | 53 | 241221 |
| 265 x 83.5 | grey / black | piece | Arb.-Luft (Work air) | 53 | 241230 |
| 105 x 83.5 | grey / black | piece | bar | 53 | 241231 |
| 330 x 83.5 | grey / black | piece | Betriebsluft (Operating air) | 53 | 241232 |
| 290 x 83.5 | grey / black | piece | Instr.-Luft (Instr. air) | 53 | 241233 |
| 435 x 83.5 | grey / black | piece | PRESSLUFT (COMPRESSED AIR) | 53 | 241234 |
| 475 x 83.5 | grey / black | piece | SYNTH.-LUFT (SYNTH. AIR) | 53 | 241235 |
| 265 x 83.5 | grey / black | piece | Regelluft (control air) | 53 | 241236 |
| 280 x 83.5 | grey / black | piece | Förderluft (conveying air) | 53 | 241237 |
| 635 x 83.5 | white / black | piece | LEERE FLASCHEN (EMPTY BOTTLES) | 53 | 241240 |
| 475 x 83.5 | blue / white | piece | SAUERSTOFF (OXYGEN) | 53 | 241250 |
| 290 x 83.5 | purple / white | piece | Ammoniak (Ammonia) | 53 | 241260 |

* Customised text possible when ordering larger quantities.

REGOPLAST®- CABLE MARKERS

FAST AND PERMANENT LABELLING OF CABLES

The Regoplast® cable marking system, consisting of the 0081 and 1980 series, enables simple, fast and permanent labelling of cables and wires at any location. Both series consist of a 2-component injection-moulded construction in which the characters and carriers are

permanently bonded together by injection moulding. Their area of application: any form of electrical cable, in special machine construction, solar system and photovoltaic system labelling, telephone and data transmission cables, device construction, wire designation in switch

panel construction, medical systems and much more. The cable markers are UV-stable, scratch-resistant, insensitive to heat and cold and largely resistant to solvents, acids and alkalis.



Cable markers series 1980 in assortment box see page 36

Item no. 321582



Cable marker yellow black



Cable marker red white



Cable marker yellow black assembled



Perforated tape on a roll (30 m)



CABLE MARKERS SERIES 0081 AND ACCESSORIES

The 0081 series markers are plugged into each other, are self-locking and therefore do not require a carrier. With their small size (6 x 4 x 3 mm), they are very suitable for low cable cross-sections. There is a block at the beginning and end for fastening with a cable tie. Possible applications: Marking of cable bundles, cable harnesses, in the visible area of switch cabinets, special machine construction.

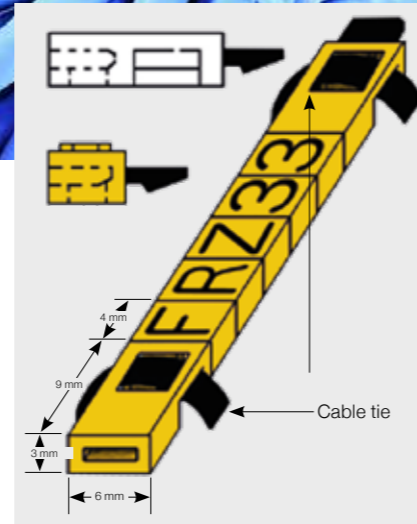

All parts of the cable labelling are individually pluggable.

| Cable markers series 0081 and accessories | | | | | | |
|---|----------------------|----------------|--|----------------|---|----------|
| Description | Bascolour/Textcolour | Packaging unit | Material | Size mm | Capital letters / numbers / symbol | Item no. |
| Marker 0081 | yellow / black | 100 / Symbol | Polyethylene | 6 x 4 x 3 | 0-9 / A-Z, Slash, full stop, hyphen, colon, blank, plus sign (+), start and end block | 311500 |
| | white / black | | | | " | 311510 |
| Cable tie | light blue | 100 | Polyamide 6.6 | 92 x 2.4 | detectable (see description) | 311519 |
| Cable tie | black | 100 | Polypropylene | 92 x 2.4 | - | 311520 |
| Collet chuck WT1 | | 1 | | - | - | 311521 |
| Cable scissors | | 1 | | - | - | 311522 |
| Assortment box (44 compartments) | blue | 1 | Steel | 485 x 365 x 42 | - | 311523 |
| Tool ERG50 | black / orange | 1 | Tool for plastic-cable ties (2.4-4.8 mm), adjustable setting force, automatic burr-free cut, section remains on the tool, etc. | | | 311524 |

* Please insert the desired letter/number/character after the item number (example: 311500/ A).

| Cable markers series 0081 in assortment box | | | | | | |
|---|-------------|----------------------|--|---------------------|-------------|----------|
| Size box in mm (L x W x H) | Version box | Bascolour/Textcolour | Content / symbols / accessories | Quantity per symbol | Total parts | Item no. |
| 485 x 365 x 42 | Sheet steel | yellow / black | 0-9 / A-Z, slash, dot, hyphen, colon, blank, start and end block (double quantity each), 100 pcs. cable ties, 1 pc. cable shears | 30 | 42 / 1,290 | 311530 |
| | | | " | 50 | 42 / 2,150 | 311531 |
| | | | " | 100 | 42 / 4,300 | 311532 |
| | | | " | 150 | 42 / 6,450 | 311533 |
| | | white / black | " | 30 | 42 / 1,290 | 311540 |
| | | | " | 50 | 42 / 2,150 | 311541 |
| | | | " | 100 | 42 / 4,300 | 311542 |
| | | | " | 150 | 42 / 6,450 | 311543 |

CABLE MARKERS SERIES 1980 AND ACCESSORIES

The Regoplast® 1980 series cable markers are used in the chemical and food industries and in special machine construction and are largely resistant to chemicals, solvents and lubricants. The markers can be assembled by Regoplast® as shown on perforated polypropylene tape (321570), stainless steel tape (individual order number) and profile rail (321573). They are attached to the cable with stainless steel tape (especially for the food industry) or cable ties.



Slide the cable markers individually onto the perforated tape. The «lugs» in the cable makers allow them to snap into the openings of the perforated tape. Then pull the cable tie at both ends through the openings and secure it to the medium.

| Cabel markers series 1980 and accessories | | | | | | | |
|---|---|------------|--|----------------|----------------------|---------------|--------|
| Description | Material | Size mm | Capital letters / numbers / symbol | Packaging unit | Bascolour/Textcolour | Item no. | |
| Marker 1980* | Polypropylene | 13 x 9 x 4 | 0-9 / A-Z, slash, dot, hyphen, colon, blank, + sign, = sign, arrow (flow direction right/left or up/down), open/close bracket ([]), Special characters lower case letter i, e | 100 per symbol | yellow / black | 321550 | |
| | | | | | " | red / white | 321551 |
| | | | | | " | white / black | 321560 |
| | | | Blank fields | | red | 321564/a | |
| | | | | | green | 321564/b | |
| | | | | | blue | 321564/c | |
| | | | | | orange | 321565/a | |
| | | | | | purple | 321565/b | |
| | | | | | grey | 321565/c | |
| | | | | | black | 321565/d | |
| | brown | 321565/e | | | | | |
| Perforated tape (in cassette) | Polyamide 6/6 | 7.6 x 0.5 | | 50 m roll | black | 321570 | |
| Profile rail | Rigid PVC | 1,000 x 17 | | 1 | | 321573 | |
| Cable tie | Polypropylene | 208 x 3.6 | | 100 | | 321574 | |
| | Polyamide 6/6 | 200 x 3.6 | | 100 | | 321576 | |
| Cable tie | Polyamide 6/6 | 186 x 4.8 | detectable | 100 | light blue | 321575 | |
| Collet chuck WT1 | | | | 1 | - | 321521 | |
| All-purpose scissors | see also series 0081 | | | 1 | - | 311522 | |
| Assortment box (44 compartments) | Sheet steel 485 x 365 x 42 (see also series 0081) | | | 1 | blue | 311523 | |
| Tool ERG50 | Tool for plastic cable ties (2.4-4.8 mm), adjustable setting force, autom. burr-free cut, section remains on the tool - ideal for food processing industry etc. (see description) | | | | | 311524 | |

* Please insert the desired letter/number/character after the item number (example: 321550/ A).

Cable marking series 1980 in assortment box on the next page >

ASSEMBLED CABLE MARKERS



CABLE MARKING ASSORTMENT BOXES

They bring order to the variety: our assortment boxes

Clearly organised in the assortment box you will find everything you need for permanent cable marking you need.

Assortment: per number / letter / special character: 30, 50, 100 or 150 pieces including perforated tape, cable scissors and cable ties.



ASSORTMENT BOXES

| Cable markers series 1980 in assortment box | | | | | | |
|---|----------------|---------------------------|--|------------------------|-------------|----------|
| Size box mm L x W x H | Version box | Basecolour/ Textcolour | Content / symbols / accessories | Quantity per symbol | Total parts | Item no. |
| 485 x 365 x 42 | Sheet steel | yellow / black | 0-9 / A-Z, slash, dot, hyphen, colon, blank, comma, =-sign, 100 cable ties, 1 pair of cable shears, 50 m perforated tape | 30 | 42 / 1,260 | 321580 |
| | | | | 50 | 42 / 2,100 | 321581 |
| | | | | 100 | 42 / 4,200 | 321582 |
| | | | | 150 | 42 / 6,300 | 321583 |
| | | white / black | " | 30 | 42 / 1,260 | 321590 |
| | | | | 50 | 42 / 2,100 | 321591 |
| | | | | 100 | 42 / 4,200 | 321592 |
| | | | | 150 | 42 / 6,300 | 321593 |
| | | red / white | " | 30 | 42 / 1,260 | 321594 |
| | | | | 50 | 42 / 2,100 | 321595 |
| | | | | 100 | 42 / 4,200 | 321596 |
| | | | | 150 | 42 / 6,300 | 321597 |

WE TAKE CARE OF THE ASSEMBLY

Do you need customised cable markers? Get in touch with us. Regardless of whether you need several of the same or many with different texts or information. We supply you with ready-made cable markers, mounted on

perforated plastic tape, stainless steel tape or profile rails, for example for our customers in the food industry, and pre-sort them according to your requirements. And all this at an extremely favourable price, which is particularly

worthwhile when you compare the time and costs for your own personnel. That's why many of our customers use this service.

| Loose cable marker series 1980 | | |
|--------------------------------|-----------------------|-----------|
| Description | Basecolour/Textcolour | Item no. |
| Cable marker | yellow / black | BB1624910 |
| | white / black | BB1624910 |
| | red / white | BB686810 |

| Loose cable marker series 0081 | | |
|--------------------------------|-----------------------|----------|
| Description | Basecolour/Textcolour | Item no. |
| Cable marker | yellow / black | BB234520 |
| | white / black | BB234520 |

Assembly Series 1980 mounted on stainless steel band

| Lenght mm | for... pieces | Item no. |
|--------------|------------------|-----------|
| 60 | 2 | BB263110 |
| 65 | 3 | BB1753510 |
| 75 | 4 | BB1753520 |
| 85 | 5 | BB204110 |
| 95 | 6 | BB204120 |
| 105 | 7 | BB204130 |
| 115 | 8 | BB222610 |
| 125 | 9 | BB1649920 |
| 135 | 10 | BB202710 |
| 145 | 11 | BB1639410 |
| 155 | 12 | BB1658410 |
| 165 | 13 | BB1649930 |
| 175 | 14 | BB240710 |
| 185 | 15 | BB1709510 |
| 195 | 16 | BB1690510 |
| 205 | 17 | BB1690520 |
| 215 | 18 | BB1690530 |
| 225 | 19 | BB243030 |
| 235 | 20 | BB1804510 |
| 245 | 21 | BB243040 |
| 255 | 22 | BB243050 |
| 265 | 23 | BB243041 |
| 275 | 24 | BB243042 |
| 285 | 25 | BB243043 |
| 295 | 26 | BB243044 |
| 305 | 27 | BB2083630 |

Assembly Series 1980 mounted on perforated tape

| Lenght mm | for... pieces | Item no. |
|--------------|------------------|-----------|
| 55 | 1 | BB285010 |
| 60 | 2 | BB285020 |
| 65 | 3 | BB285030 |
| 75 | 4 | BB1624945 |
| 85 | 5 | BB1624950 |
| 95 | 6 | BB1624960 |
| 100 | 7 | BB1624920 |
| 105 | 8 | BB1624970 |
| 115 | 9 | BB1624980 |
| 125 | 10 | BB1624985 |
| 135 | 11 | BB1624986 |
| 145 | 12 | BB162489 |
| 150 | 13 | BB1624987 |
| 155 | 14 | BB1624988 |
| 160 | 15 | BB256030 |
| 165 | 16 | BB256035 |
| 170 | 17 | BB256036 |
| 175 | 18 | BB256037 |
| 180 | 19 | BB256039 |
| 190 | 22 | BB256040 |
| 195 | 23 | BB256020 |
| 200 | 24 | BB25692 |
| 205 | 25 | BB256080 |
| 220 | 28 | BB256010 |
| 235 | 31 | BB256091 |
| 475 | 58 | BB256090 |

other sizes on request

Assembly Series 0081 plugged into each other and self-locking

| Number of letters | Item no. |
|-------------------|----------|
| 1 - 11 | BB238510 |
| 12 - 15 | BB238515 |
| 16 - 18 | BB238525 |
| 19 - 20 | BB238535 |
| 21 - 25 | BB238545 |
| 26 - 28 | BB238546 |
| 29 - 31 | BB238547 |
| 32 - 34 | BB238548 |

(all details incl. start and end block)



ACCESSORIES

CABLE MARKING ACCESSORIES

Self-laminating, labelling cable and wire markers

PVC labelling strips for cable identification, self-adhesive film consisting of writing field (white) and protective film, cut into 6 strips on cards for easy removal. Delivery form: In pocket packs of 10 cards and 6 strips per card (= 60 strips).

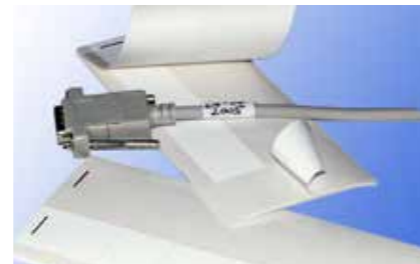

PVC labelling strips

LABELLING STRIP

Item number: 311600

Size: 75 x 25 mm
 Labelling field white 25 x 25 mm
 Booklet size: 75 x 160 mm



CABLE TIES

Item number: 311519 | 311520
 Colour: light blue | black
 Material: Polyamide 6.6 | Polypropylene
 92 x 2,4 mm
 detectable | non-detectable



CABLE SHEARS

Item number: 311522
 Colour: blue



TOOL ERG50

Item number: 311524

Patented cutting mechanism with recoil damping. Ergonomic shape with rounded contours for maximum user comfort.

Unique 360° rotating attachment for use in any position. Adjusting ring for regulating the setting force with easy

access. Adjustment up to 5 times faster than with conventional tools.

- tool for plastic cable connectors from 2.4 - 8.4 mm
- adjustable crimping force
- automatic, degree-free cut
- section remains on the tool
- etc.

DETECATABLE CABLE TIES

TY-RAP® PREMIUM CABLE TIE WITH STEEL NOSE CAP

from ABB have been developed with a special polymer compound that activates metal detectors, X-ray equipment and visual recognition systems. These new cable ties are recommended wherever cable tie residues have no place in the end product and detectors are used to detect foreign bodies such as in the food and pharmaceutical industries.

- detectable by metal detectors
- detectable by X-ray equipment
- easy visual recognition due to the blue color scheme
- helps your company to implement the HACCP EU directive
- Available as a floatable polypropylene version for use in liquid processing environments
- available in 4 different sizes in handy packaging units

Item number: 321575



SPEC-KON® CABLE TIE

help you solve cable bundling in plant, construction, service, industrial and many other sectors. They are particularly suitable for attaching our cable markers. Due to their special structural properties, Spec-Kon® cable ties are suitable for use in special environmental conditions such as moisture, heat and cold.

The design of the head part and the closure guarantee strong and durable resistance even under special temperature conditions. The entire Spec-Kon® product line is made of polyamide 6.6, a material that ensures maximum tensile strength, self-extinguishing and, in the black version, heat and UV resistance. These new cable ties are recommended wherever cable tie residues have no place in the end product and detectors are used to detect foreign bodies such as in the food and pharmaceutical industries.

ABB's cable tie tools guarantee optimum positioning of the cable ties, with the cable tie end being cut off flush, thus avoiding sharp protrusions and pointed edges.

Item number: 321574



PAPER PRESSING



DURABLE PROTECTION AGAINST ALMOST ALL CHEMICALS

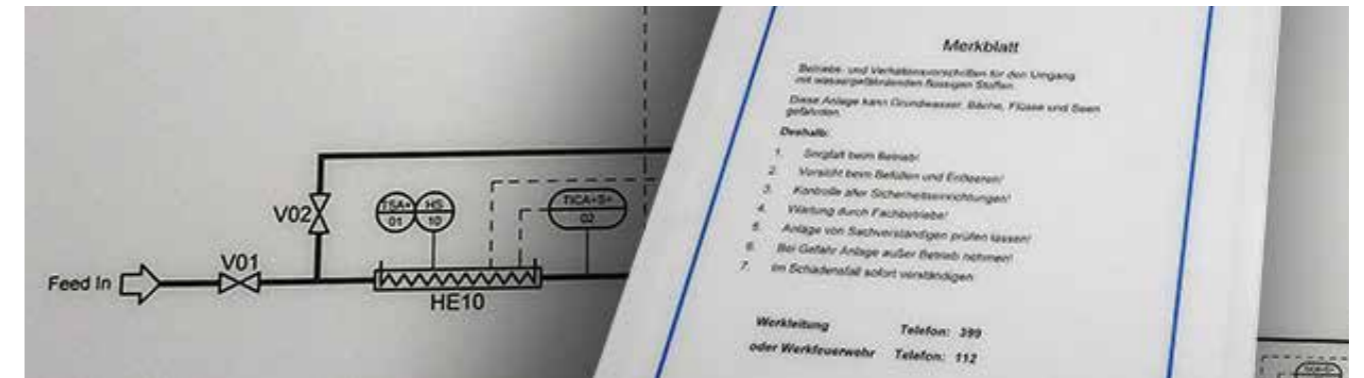

In this process, templates in the form of drawings, printed films or posters are incorporated into PVC and pressed with transparent

PMMA film (matt or high-gloss).

Where many people work and complicated machines have to be operated, instruction sheets, operating instructions or explanato-

ry drawings are often useful. However, these must withstand the influences at their place of use, both in everyday life and in exceptional situations. These influences include, for example, high solar radiation, rain, dust or a wide variety of chemicals.

To prevent posters and drawings from fading or smudging, we use the process of paper pressing: Your artwork serves as the starting material, which we incorporate into resistant rigid PVC and press with a transparent PMMA film.

Depending on which look you prefer, you can choose either a matte or a glossy film. We are happy to implement the supplied template in a smaller or larger version. The final product can be produced up to a size of 1,300 mm x 790 mm.

- ✔ permanent resistance to almost all chemicals.
- ✔ extensive UV stability due to the use of a high-quality PMMA film.

Choice of transparent-matt or transparent-high-gloss paper pressing

| Description | Material | Thickness in mm | Size in mm | | Item no. |
|----------------|----------|-----------------|--------------|-------------|----------|
| | | | | | |
| Paper pressing | PVC | 1.5 | up to DIN A5 | 210 x 148 | 411650 |
| | | | up to DIN A4 | 297 x 210 | 411651 |
| | | | up to DIN A3 | 420 x 297 | 411652 |
| | | | up to DIN A2 | 594 x 420 | 411653 |
| | | | up to DIN A1 | 841 x 594 | 411654 |
| | | | up to size | 1,300 x 790 | 411655 |
| Paper pressing | PVC | 2 | up to DIN A5 | 210 x 148 | 411660 |
| | | | up to DIN A4 | 297 x 210 | 411661 |
| | | | up to DIN A3 | 420 x 297 | 411662 |
| | | | up to DIN A2 | 594 x 420 | 411663 |
| | | | up to size | 1,300 x 790 | 411665 |
| Paper pressing | PVC | 2.5 | up to DIN A5 | 210 x 148 | 411670 |
| | | | up to DIN A4 | 297 x 210 | 411671 |
| | | | up to DIN A3 | 420 x 297 | 411672 |
| | | | up to DIN A2 | 594 x 420 | 411673 |
| | | | up to size | 1,300 x 790 | 411675 |

Drill holes are charged additionally

INSPECTION TAGS



SELF-ADHESIVE INSPECTION TAGS

Regular inspections are mandatory for machines, electrical systems, distribution and control cabinets as well as switches and sockets. The main purpose of this is to detect any defects or faults - and ultimately to ensure the necessary safety in large industrial plants.

Regoplast® offers you specific solutions in the area of inspection stickers and seals. On the one hand, this includes a standard version: a booklet of 100 inspection stickers in the colours yellow, green, red and blue. On the other hand, we are also happy to consider individual customer requests.



Rectangular, practical, good: our 100 booklet.



The booklet contains inspection stickers in four bright colours - for optimum visibility.

INSPECTION STICKERS AND FASTENINGS: CUSTOMISABLE AND TAMPER-PROOF

We print our inspection stickers on document-proof security film: this means that the labelling remains clearly legible even months and years after the date of issue. In addition, the test seals cannot be tampered with by unauthorised

persons as they tear when removed. All inspection stickers are manufactured in accordance with DGUV regulation 3. On request with customised text (for example „Next inspection date“ or with your company logo), with

the year and months or with a standard text. We offer our self-adhesive inspection stickers in practical booklets with 10 sheets of 10 stickers each.

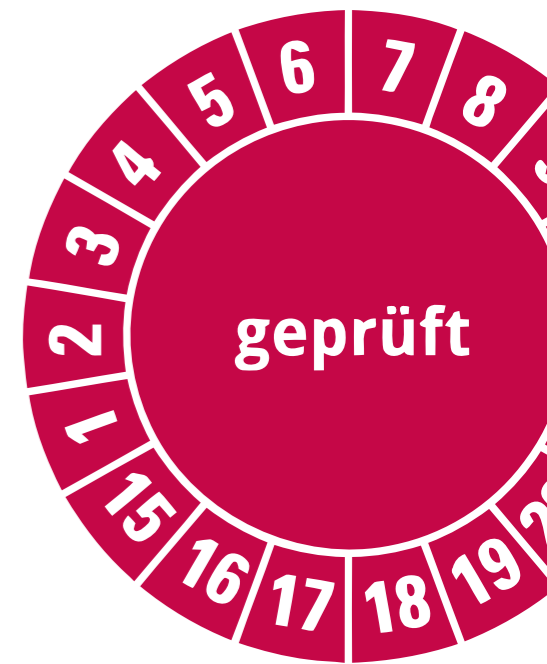

- ✓ Inspection tags for security marking
- ✓ Inspection tags on forgery-safe protective foil
- ✓ self-destructive

Standard version inspection tags

Labelling for the safety sector

Inspection stickers on indelible safety film, self-destructing, with imprint „acc. to DGUV 3“

(German Social Accident Insurance, regulation 3)

Area of application: electrical devices etc.

| Version | Size mm (booklet) | ø mm (inspection tag) | Colour according to DIN | Text | Packaging unit | Item no. |
|---|-------------------|-----------------------|-------------------------|----------|-----------------|----------|
| Inspection sticker booklet with 10 pages of 10 inspection stickers = 100 pieces | 175 x 75 | 25 | yellow | see fig. | piece / booklet | 511700 |
| | | | green | | | 511701 |
| | | | red | | | 511702 |
| | | | blue | | | 511703 |
| Chrome-plated punch pliers | | | | | piece / booklet | 511710 |

Customised products on request

INSPECTION PLATES AND FASTENINGS



INSPECTION TAGS FOR THE ELECTRICAL ENGINEERING SECTOR

A large proportion of our inspection tags are used in electrical engineering, for example to mark inspected plugs, lamps or junction boxes. For this range we offer different designs each in a set of 100. From the inscription "next exam" to the year with 12 months, everything is there. If you do not

find what you are looking for in our range, we will be happy to adapt our Inspection tags to your individual requirements. Like all our products, our self-adhesive Inspection tags also convince with high material quality – in this way we guarantee their longevity.



| Inspection tags for the electrical engineering sector | | | | | |
|--|---------|-------------|------------|----------------|----------|
| Version | Size mm | Colour | Text | Packaging unit | Item no. |
| next inspection | 80 x 40 | white | see fig. 1 | 100 | 511711 |
| Inspection in acc. with accident prevention regulations (UVV), next inspection | 80 x 40 | white | see fig. 2 | 100 | 511712 |
| year with 12 months | ø 35 | by year | see fig. 3 | 100 | 511713 |
| next inspection | ø 30 | yellow | see fig. 4 | 100 | 511714 |
| year with 12 months | ø 15 | by year | see fig. 5 | 100 | 511715 |
| protective foil in booklet | ø 25 | transparent | - | 100 | 511716 |

STABILITY THAT GOES BEYOND THE STANDARD

Finding innovative solutions for industry-specific requirements has always been one of our trademarks. Our rigid PVC inspection stickers are one such innovative solution: they are used wherever self-adhesive stickers are difficult to attach or where special

resistance is required, such as lifting vehicles, cranes, pressurised containers or safety valves. The stickers can be attached using special eyelets, and if the test is passed successfully, the sticker is punched in the appropriate place.



Our rigid PVC labels are ideal for labelling pressurised containers.

Hard PVC inspection tags

Area of application: Preventive operational maintenance, maintenance and oil change intervals, lifting vehicles, cranes, containers, valves, small appliances, etc.

| Colour acc. to DIN 2403 / 2404 | ø mm | Text | Packaging unit | Item no. |
|-----------------------------------|------|------------|----------------|----------|
| yellow | 32 | siehe fig. | 100 | 511720 |
| red | | | | 511721 |
| orange | | | | 511722 |
| green | | | | 511723 |
| grey | | | | 511723/a |
| Suitable towing eyelet on request | | | | 511730 |

Hard PVC inspection tags, incl. eyelet

Area of application: Safety valves, pressure vessels, etc.

| Colour acc. to DIN 2403 / 2404 | ø mm | Text | Packaging unit | Item no. |
|--------------------------------|------|------------|----------------|----------|
| yellow | 75 | siehe fig. | 100 | 511740 |
| green | | | | 511741 |
| red | | | | 511742 |
| blue | | | | 511743 |
| brown | | | | 511744 |
| orange | | | | 511745 |

(PVC-) NEGATIVE PRESSURE SIGNS AND BUILDING LABELLING



NEGATIVE PRESSURE SIGNS, SUITABLE FOR OUR SIGN HOLDERS AND PROFILE RAILS

Standard solutions and individualised products are our trademark - and this also applies to our signs manufactured using the underprint process. In addition to general symbols, we are also happy to produce an underprint sign with your desired imprint on request.

Highly visible information is essential to keep day-to-day operations running in industrial, technical and trade companies - not to mention exceptional situations such as an incident. Our vacuum signs ensure safety in numerous sectors. The standard versions include vacuum signs with a fire extinguisher symbol or a reference to a permissible ceiling load. You should also not do without our „safety calendar“: This incorporates manually adjustable number fields that show how many days the company has been working

accident-free. We are also happy to realise various signs according to your wishes. Our underprint signs are made of scratch-resistant and largely UV-resistant rigid PVC. They are also resistant to most chemicals.

The signs also impress with their stability and easy handling when it comes to mounting. Most versions fit easily on our sign holders and profile rails with quick-mounting tape made of VA-steel or polyamide.

| 29 mm negative pressure signs | |
|-------------------------------|--|
| Item no. | |
| 531950 | |
| 531951 | |
| 531952 | |
| 531953 | |
| 531954 | |

| Regoplast® PVC negative pressure sign „Fire extinguisher“ suitable for profile rail by the metre 1,000 x 200 mm see pipework labelling (Item no. 110033) | |
|---|--|
| Item no. | |
| 531820 | |
| 531821 | |

| Regoplast® PVC negative pressure sign „SBA Incident V“ suitable for profile rail 1,000 x 200 mm (Item no. 110033) suitable for profile rail 1,000 x 86.5 mm (Item no. 110032) suitable for profile rail 1,000 x 50 mm (Item no. 110031) | |
|--|--|
| Item no. | |
| 521780 | |
| 521781 | |
| 521782 | |

| Regoplast® PVC negative pressure sign (with the option of engraving the weight) | |
|---|--|
| Item no. | |
| 531835 | |



SIGN-IN SHEETS



GET YOUR QUOTE NOW!

www.regoplast.de/en/products/sign-in-sheets/

PRECISELY TAILORED TO YOUR COMPANY

In addition to an extensive standard program, Regoplast® GmbH offers you further individual solutions. In addition to a wide variety of solutions in the area of operational labeling and hazardous goods labeling, this also includes our registration boards, which we adapt precisely to your requirements using our components.

You choose the number of compartments and rows, color coordination and eventual imprint or engraving of logo or lettering, slogan or notice texts. The elements on the panels made of 2 and 3 millimeters thick Aludibond or PVC are firmly glued to the panel and can withstand the daily routine in an industrial hall and, due to the clean and high quality workmanship, can also look good in reception areas, hallways and offices.

See at a glance who is present and who is not – this creates clarity and thus saves time and organizational effort. Our registration boards consist of a carrier plate made of 2 or 3 mm thick PVC or Alu-Dibond material with firmly glued aluminum rails. Several plastic



Thanks to its clean and high-quality finish, the notice board looks good in offices or corridors.



This reception area is a sight to behold: Here, the registration board also creates a tidy look.

formation texts are possible. Thanks to the durable materials and high-quality workmanship, our registration boards combine an elegant, simple look with maximum stability. In this way, they are suitable for all areas of a business, from a reception hall to an open-plan office to a sprawling industrial hall.

signs can be inserted into each of these rails. You decide how many compartments and rows there should be. In addition, various color designs and imprints such as lettering, slogans or in-



BADGES

WE MANUFACTURE BADGES, CUSTOMISED TO YOUR WISHES

You want your guests to be able to address your employees personally or that the personnel of external companies present can be recognized quickly and thus ensure transparency in your company. Then our badges are just the right solution for you. We manufacture them according to customer requirements in various variants.

BADGES TO MATCH OUR REGISTRATION BOARDS

For employees and staff from external companies working for your company, it makes sense to combine our badges with our registration boards described on pages 48 and 49. This means you don't have to keep creating new badges and, if the worst comes to the worst, you can immediately see which employees are in the factory or offices and which are not.

YOU CHOOSE THE MATERIAL, WE ...

Decide on the version of badges you require, the material, format and colour - we will then manufacture your badges according to your wishes. Whether as a badge holder or as a sturdy badge printed with your logo and the corresponding name.



Our transparent ID card sleeves can be easily fitted with the labelled cards from the top.

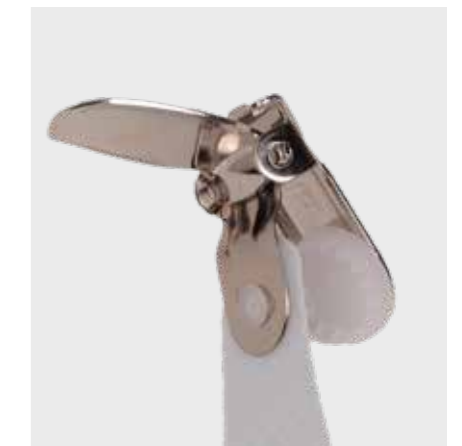

The extremely sturdy clips we use ensure a secure hold on clothing even after many years of use. And that applies even more to the material we use.



Materials

- Paper printed (registration card)
- PVC engraved
- Polysterol printed & laminated

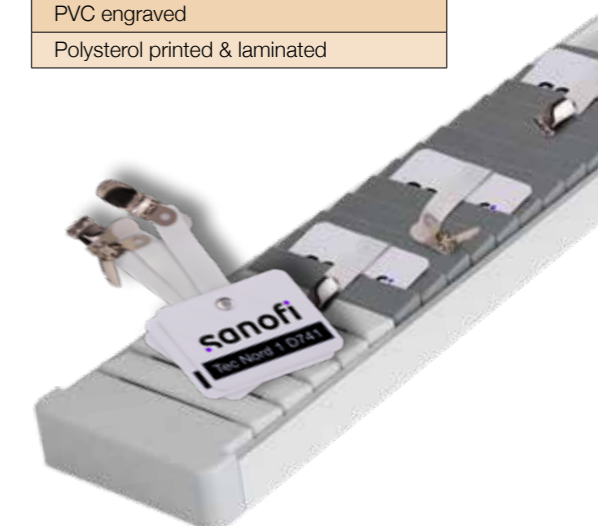

GET YOUR QUOTE NOW!

www.regoplast.de/en/products/badges/

PRODUCTS FOR INDUSTRY, TRANSPORT AND CRAFTS



Our extensive product range is used in the chemical and petrochemical industry, the heating oil and mineral oil sector, plant engineering, process engineering and the automotive and food industries for labelling pipelines and electrical cables in compliance with the labelling regulations in these areas. In addition to pipeline labelling, vacuum signs, cable markings and safety markings, our product range has also included various labelling systems for the transport of dangerous goods for many years. In particular, this includes our hazardous goods warning signs made of

stainless steel 1.4301 in accordance with RN. 10500 para. 6 GGVS/ADR.

HOW TO FIND US:

